



HAL
open science

COOLABILITY OF BLOCKED REGIONS IN A ROD BUNDLE AFTER BALLOONING UNDER LOCA CONDITIONS. MAIN FINDINGS FROM A REVIEW OF PAST EXPERIMENTAL PROGRAMMES

Claude Grandjean

► **To cite this version:**

Claude Grandjean. COOLABILITY OF BLOCKED REGIONS IN A ROD BUNDLE AFTER BALLOONING UNDER LOCA CONDITIONS. MAIN FINDINGS FROM A REVIEW OF PAST EXPERIMENTAL PROGRAMMES. Nuclear Engineering and Design, 2007, 237, pp.1872-1886. 10.1016/j.nucengdes.2007.02.022 . irsn-00175856

HAL Id: irsn-00175856

<https://hal-irsna.archives-ouvertes.fr/irsna-00175856>

Submitted on 1 Oct 2007

HAL is a multi-disciplinary open access archive for the deposit and dissemination of scientific research documents, whether they are published or not. The documents may come from teaching and research institutions in France or abroad, or from public or private research centers.

L'archive ouverte pluridisciplinaire **HAL**, est destinée au dépôt et à la diffusion de documents scientifiques de niveau recherche, publiés ou non, émanant des établissements d'enseignement et de recherche français ou étrangers, des laboratoires publics ou privés.

**COOLABILITY OF BLOCKED REGIONS IN A ROD BUNDLE
AFTER BALLOONING UNDER LOCA CONDITIONS.
MAIN FINDINGS FROM A REVIEW
OF PAST EXPERIMENTAL PROGRAMMES**

Claude GRANDJEAN
IRSN - Institut de Radioprotection et de Sûreté Nucléaire
DPAM- BP3 13115 St Paul-Lez-Durance, France,
claude.grandjean@irsn.fr

ABSTRACT

IRSN has carried out a State-of-the-Art-Review of the main experimental programmes related to fuel behaviour under Loss-of-Coolant-Accident (LOCA) conditions conducted from the 70s until now, that has been split in three parts. The second part is devoted to the question of the coolability of blocked regions in a rod bundle after ballooning in a LOCA. The main findings from this part are presented here. The experimental characteristics and main results of the FEBA, SEFLEX, THETIS, ACHILLES, CEGB and FLECHT SEASET programmes, as well as several analytical developments performed in association with these experimental programmes, were examined in detail in this review. The comparison and combination of conclusions drawn from these results and studies were used to improve our understanding of the physical phenomena governing the behaviour of a partially blocked rod array during a LOCA reflood scenario. It has also been possible to determine the limits of blockage coolability under the most severe geometric (blockage ratio and length) and thermohydraulic conditions. Thus, even a severe blockage ratio (90%) of a moderate length (<10 cm) does not cause any particular problems in terms of coolability during two-phase reflood. However, a severe blockage with considerable axial extension (> 15 cm) and a high blockage ratio (> 80%) can lead – under low reflood conditions – to a significant increase in blockage surface temperatures, hindering the final coolability of this blockage. It is important to underline that these results were obtained in out-of-pile experiments performed with electrically heated fuel rod simulators with a large gap between simulator and cladding bulge, thus not allowing to simulate the possible fuel accumulation occurring in cladding balloons (fuel relocation), as was observed during all in-pile tests with irradiated fuel rods. The impact of fuel relocation upon blockage coolability therefore remains to be investigated.

1 INTRODUCTION

Many experimental programmes have been devoted to studying rod cladding deformations produced during a loss-of-coolant-accident (LOCA) transient and the resulting local flow restriction ("blockage") that may occur in the assembly. State-of-the-art reviews (Parsons *et al.*, 1986, USNRC/ONRR, 1988, Grandjean, 2005) have been performed within the last twenty years, in which the main characteristics and conclusions drawn from results of the most important of these programmes have been extensively examined.

The problem of cooling partially blocked fuel assemblies varies according to the LOCA type (corresponding to the break size) and in relation to coolant flow characteristics in the blockage region. For a large break LOCA scenario, flow blockages resulting from clad swelling mainly occur during adiabatic and reflood phases. These blockages are thus cooled down by a two-phase mist flow during the greater part of the thermal transient preceding rod quench. Cooling conditions near a blockage can therefore be defined as the combination of the following complex thermohydraulic features:

- Flow redistribution upstream and downstream from the blockage, which leads to a flow decrease within and downstream from the blockage, thereby reducing heat transfer in that region,
- An increase in the liquid fraction in the coolant flow approaching the blockage, due to droplet inertia, which enhances heat transfer with blockage surfaces,
- Intensification of turbulence within the blockage, caused by droplet impact on balloons surfaces and shattering which reduces steam superheat and favours cooldown.

The consequence of these effects greatly depends on the blockage characteristics (blockage ratio, axial extension) and coolant conditions (flow rate, system pressure, inlet temperature). The combination of the different effects can either degrade or, on the contrary, improve cladding/ coolant exchanges in the vicinity of the blockage under large break LOCA conditions.

Several analytical experimental programmes were launched with the intention of assessing this specific issue. Among these programmes, four major programmes are worth mentioning: FEBA and SEFLEX in Germany, THETIS in the UK and FLECHT-SEASET in the USA have all provided the main body of experimental comparative results. These results have been used to improve the large-break LOCA reflood analytical models and determine an

upper limit in blockage ratio still amenable to cooling. This limit is still accepted in safety evaluations. The SCTF tests conducted by JAERI are also worth mentioning, but will not be discussed here, in consideration of the low maximum blockage ratio (62%), that led to insignificant effects in the various tests conducted.

The above-mentioned programmes all consist of out-of-pile thermohydraulic tests on rod simulator assemblies containing a blockage. For obvious practical reasons, deformed geometries were pre-shaped and fixed all along the tests. The size and length of the pre-shaped balloons were based on the results from multi-rods ballooning experiments, mainly from the programmes conducted in Germany (REBEKA), USA (MRBT) and Japan (Parsons *et al.*, 1986). In particular, JAERI tests (Japan) have shown the possibility of severe flow restriction (up to 90%) and axially extended contacts between rods (over more than 20 cm) in bundle configurations with an outer shroud and guard heaters so as to minimize radial heat losses.

The main experimental characteristics and results of these four programmes will be presented in the next section. Various analytical developments performed in association with these experimental programmes will be indicated in the subsequent section. Conclusions drawn from these results and studies are summarised in the last section.

2 REVIEW OF MAIN EXPERIMENTAL PROGRAMMES

2.1 FEBA and SEFLEX programmes

These two complementary programmes were performed successively in the same facility at FZK (Forschungszentrum Karlsruhe).

2.1.1 Objectives

The FEBA (Flooding Experiments with Blocked Arrays) programme (Ihle and Rust, 1984) involved performing separate effects tests under different reflood conditions (reflood rate, system pressure and feedwater temperature) with the specific aim of quantifying the effects of:

- A partial blockage in a group of fuel rods, with the presence of a by-pass region or not (non-deformed fuel rods at the blockage periphery) and,
- The presence of spacer grids,

upon cladding/ coolant heat exchanges in the vicinity of the blockage.

The SEFLEX (Fuel Rod Simulator Effects in Flooding Experiments) programme (Ihle and Rust, 1986) was designed to evaluate the sensitivity of FEBA-type reflood test results on fuel rod and blockage simulation technologies. This analysis was based on a limited number of tests performed under conditions identical to those in corresponding FEBA tests, thus enabling the immediate comparison of results.

2.1.2 Experimental characteristics of tests performed on 5x5 rod bundles

The heater rods used in FEBA bundle tests were "solid-type" simulators, each composed of a heated spiral element embedded in a magnesium oxide insulator, itself tightly encased in 1 mm thick stainless steel cladding. The heater rods used in the SEFLEX tests were the more representative fuel rod electric simulators used in the REBEKA programme ; such a simulator consisted of an electrically heated rod placed in the center of annular alumina pellets, all being enclosed in a Zircaloy tube with allowance of a 0.05 mm wide gap. In both cases, these rods were 3.9 m long and held by 7 spacer grids. The axial power profile simulated a cosine profile with 7 power steps.

The 5x5 bundle is housed in a 6.5 mm thick stainless steel shroud whose large calorific capacity is used to partially simulate the thermal environment of the surrounding fuel rods.

In the FEBA tests, balloons were simulated by superimposing hollow sleeves onto a group -or the whole bundle- of rods in a coplanar manner. Two blockage ratios were chosen: 62% and 90%. The stainless steel sleeves were 180 mm long for maximum blockage lengths of 125 mm (62%) and 65 mm (90%) respectively. These sleeves were particularly thick: 1 mm in uniform thickness for the 62% blockage and 1 to 2.35 mm thick for the 90% blockage.

Unlike the FEBA tests, balloons simulated in the SEFLEX assembly were obtained by pre-deforming a Zircaloy tube inside an appropriately sized mould until the intended geometry was obtained. This procedure produces a cladding thickness in the deformed part of the tube that is representative of the thickness observed on a nuclear reactor fuel rod having undergone a LOCA swelling phase. The balloons formed in this manner have axial dimensions equivalent to those obtained in the FEBA sleeves: a total deformed length of 180 mm for a deformed length of 65 mm with a blockage ratio of 90%. FEBA and SEFLEX 90% blockages are illustrated in figures 1A and 1B.

[Insert Figures 1A and 1B]

2.1.3 FEBA test matrix

After a preliminary series of tests carried out on a 1x5 row of rods, the main FEBA tests were performed with 5x5 rod arrays. These 5x5 rod bundle tests may be divided into 8 series, each corresponding to a different grid and blockage scenario, as illustrated in figure 2.

[Insert Figure 2]

For test series with blockages, side plate elements were fitted between the shroud and the sleeves of the outer fuel rods in order to obtain the target blockage ratio in the corresponding sub-channels; these elements may have favoured radial thermal leaks towards the shroud, which was slightly cooler than the bundle rods.

Tests were performed using the same experimental procedure:

- Reaching initial steady-state operating conditions in stagnant steam with the required power to obtain the desired temperature at the bundle mid-plane, between 600 and 800°C;
- Establishing reflood at a constant forced rate with a power history defined according to the decay law ANS71 +20%, 40 seconds after reactor shutdown. Within the same series, the test parameters included: reflood rate, coolant inlet temperature and system outlet pressure. A pressure of 4 bar and a reflood rate of 3.8 cm/s were chosen as reference conditions.

2.1.4 FEBA main results

In brief, under the blockage conditions simulated in FEBA tests obtained by superimposing a thick sleeve to a "solid type" simulator rod, without a gap between the heated core and the cladding, results indicated that:

- With a blockage ratio of 90%, sleeve temperatures are significantly lower than temperatures recorded in the by-pass, except during the 30 seconds preceding rewetting for the test with a reflood rate of 3.8 cm/s, where sleeve rewetting is slightly delayed. Downstream from the blockage, the maximum cladding temperature of the blocked rods appears to be slightly higher (~40 °C) than the maximum temperature of the by-pass rods. This difference in temperature reaches approximately 100°C during cooldown preceding rewetting, which occurs with a delay of 45 s for the blocked rods in comparison to the by-

pass rods. However, compared with a blockage-free test under the same conditions, the maximum temperature in the test with blockage is not higher, although rewetting does occur 50 s later.

- With a blockage ratio of 62%, sleeve temperatures in the blockage are always significantly lower than cladding temperatures in the by-pass. Rewetting also occurs earlier in the blockage, except for the test with a reflood rate of 2.2 cm/s where rewetting occurs in the by-pass first. Downstream from the blockage, the maximum cladding temperature in the blocked region always appears lower than the maximum cladding temperature in the by-pass region.
- For a double blockage of 90% and 62%, located respectively upstream and downstream from the mid-plane spacer grid, behaviour in the blockages appears to be similar to that recorded in tests with only one blockage. A marked reduction in cladding temperatures is observed at the 62% blockage outlet (in comparison to those recorded in the by-pass at the same level), however, this tendency reverses further downstream where blockage cladding temperatures rise above cladding temperatures in the by-pass 200 mm downstream from this second blockage. This observation may suggest a possible penalising behaviour in a blockage configuration with long balloons.
- As expected, coolability significantly increases in the absence of a by-pass, both within and downstream from the blockage in comparison to a test with a by-pass under the same conditions.

The test series III did not include tests with a reflood rate below 3.8 cm/s. Therefore, it was not possible to evaluate the impact of a low reflood rate for a blockage ratio of 90%.

Even though the FEBA test results do not reveal any alarming behaviour impairing the coolability of a blocked fuel assembly under reflood conditions (no detrimental behaviour with a 62% blockage ratio and only a 40°C penalty upon the maximum temperature downstream from a 90% blockage), one of the major criticisms of this programme concerns the low representativity of tests in comparison to fuel rods subjected to realistic PWR conditions, where clad ballooning, which leads to flow blockage, proportionally reduces the cladding thickness, hence thermal inertia. It was also pointed out that superimposing sleeves on heater rods induces a delay in rewetting immediately downstream from the blockage due to the axial thermal conduction on rod cladding from the hot region located under the sleeve. These questions led to the carrying out of the SEFLEX tests with realistic blockage design.

2.1.5 SEFLEX test matrix

The SEFLEX tests were divided into four series:

- Series 1 was performed on a blockage-free bundle containing 7 spacer grids; rods were pressurised with helium. This series of reference tests is to be compared with the FEBA series I.
- Series 2 is a variation of series 1 using argon-pressurised fuel rods.
- Series 3 involves a 90% blockage ratio near the mid-plane elevation in a 3x3 cluster in the corner of the 5x5 array, with the mid-plane spacer grid having been removed. Fuel rods were pressurised with helium. This series is to be compared with series III of the FEBA programme.
- Series 4 is a variation of series 3 using argon-pressurised fuel rods.

Fuel rods were pressurised with helium or argon in order to study the effect of the gap thermal conductivity on the reflood behaviour: helium is the filling gas for fresh fuel rods whereas argon thermal conductivity roughly simulates that of the fission gases mixed with helium found in end-of-life spent fuel rods. The internal pressure of rods was set at 1 bar above test pressure conditions.

2.1.6 SEFLEX main results

Figure 3 compares temperature variations measured at the mid-plane of the 90% blockage for a FEBA test (Plot A) and two SEFLEX tests, with helium-pressurised (Plot B) and argon-pressurised (Plot C) rods. All three tests were performed under the same reflood conditions (3.8 cm/s, 2.1 bar). Concerning the FEBA test, the sleeve temperature is lower than the cladding temperature on a by-pass rod at the same level for a period of 300 s, after which it becomes higher until rewetting that occurs at 385 s, approximately 30 s after that on the by-pass rod. As for the SEFLEX tests, ballooned cladding temperatures are always lower than those of the by-pass rod and moreover, cladding rewetting occurs at a considerably earlier stage – around 15 s – than it does for a by-pass rod, occurring between 130 to 150 s. This difference in behaviour can be explained by the much lower thermal capacity of the SEFLEX balloons in comparison to the FEBA sleeves, as well as greater thermal decoupling from the heater rod due to a larger gap. After balloon rewetting, the temperature of the heater sheath underneath the balloon remains high, particularly for the argon-pressurised rod, due to the high thermal resistance in the 2.3 mm wide gap; this had already been observed on the FEBA test rod (Plot A), with however a narrower steam-filled gap (~ 0.8 mm).

[Insert Figure 3]

Ultimately, reflood behavioural differences between FEBA and SEFLEX tests with their respective 90% blockage simulations result from an accentuation – in and downstream from the blockage – of the effects resulting from differences in simulator design (solid-type or REBEKA-type):

- Reduction of cladding and balloon thermal capacities,
- Increase in the thermal resistance between the heater rod and the cladding or balloon.

These effects induce an early rewetting of the SEFLEX balloons and the rapid propagation of a secondary quench front downstream, leading to early rewetting of the cladding of deformed rods downstream from the blockage.

2.1.7 FEBA / SEFLEX programmes conclusions and comments

The SEFLEX tests carried out using REBEKA-type electric fuel rod simulators and a blockage simulated by initially deforming the cladding greatly helped improve the representativity of thermal behaviour observed in both blocked and unblocked regions in comparison to behaviour observed in the FEBA tests using gapless rod simulators and a blockage simulated by superimposing thick sleeves onto these rods.

Realistic fuel rod simulators (REBEKA type) lead to a noticeably earlier rewetting in comparison to solid-type fuel rod simulators (FEBA type) tested under identical conditions. Early rewetting of the cladding – even though highly decoupled from heater rod cooling – helps remove stored energy at a quicker rate throughout the rod section.

In a severe blockage (90%), simulated in a realistic manner by initial swelling of the cladding, rewetting of the central section of the balloons occurs at a very early stage due to increased turbulence and cooling from liquid droplets. Quenching progresses via secondary quench fronts upstream and downstream from the blockage, leading to earlier rewetting of the non-deformed parts of the rods near the balloons in comparison to an unblocked bundle.

Therefore, SEFLEX programme results illustrate that – within the limited range of the selected test conditions – better cooldown and significantly earlier cladding rewetting occur within and downstream from the blockage in comparison to the by-pass or during a blockage-free test.

However, it would have been beneficial that the SEFLEX test matrix include blockage tests performed under severe reflood conditions: 2 cm/s reflood rate, 2 bar pressure and inlet temperature of about 100°C. Such tests would have made it possible to evaluate the effect of favourable elements (low thermal inertia of the cladding or balloon, low conductance with the heater rod) under the most adverse thermohydraulic conditions, particularly taking into account the trends observed in FEBA and THETIS tests which partially met these conditions.

Concerning the simulation of a blockage for which the heater elements remain unchanged in the balloons and non-deformed regions, SEFLEX test results tend to highlight the marked conservatism of FEBA test results. In contrast, the marked difference between comparable test results from the two programmes seems to indicate that a high coupling between the heat source and the ballooned cladding – such as what can be found in a reactor situation for a balloon filled with relocated fuel fragments – might significantly impair the coolability of a blockage formed by such balloons in comparison to a scenario without fuel relocation. This question cannot be correctly investigated by extrapolating FEBA or SEFLEX test results and therefore requires performing specific tests.

2.2 THETIS Programme

The THETIS programme was carried out by the United Kingdom Atomic Energy Authority (UKAEA) at the Atomic Energy Establishment in Winfrith. This programme involved conducting a set of thermohydraulic tests on an assembly containing 49 full-length fuel rod simulators with a severe blockage of 90% (Pearson *et al.*, 1983) or 80% (Cooper *et al.*, 1984, Pearson *et al.*, 1984) over a length of 20 cm.

Four different types of experiments were performed:

- 1) Single-phase (nitrogen) flow heat transfer tests,
- 2) Forced reflood tests,
- 3) Gravity reflood tests,
- 4) Level swell tests.

Only forced reflood test results will be discussed in this chapter, being the greatest in number and providing analytical information on the cooling of a partially blocked assembly. Gravity reflood test results are similar, in terms of blockage coolability, to forced reflood test results conducted under comparable initial conditions, which justifies the choice of forced reflood tests for the study of partially blocked assembly cooling.

2.2.1 Experimental characteristics

The THETIS test assembly consisted of a 7x7 rod array with a 4x4 group of rods containing the blockage region. The assembly was enclosed in a square shroud tube with an inside width of 115.5 mm and a thickness of 6.5 mm. The fuel rod simulators, of SGHWR-size (12.2 mm in diameter), had a heated length of 3.58 m and were held in a set of 7 spacer grids. These fuel rod simulators were solid-type electric simulators similar to FEBA test rods.

The blockage was simulated in a 4x4 rod array separated from the shroud by one or two rows of non-deformed fuel rods, with the two rows of non-deformed fuel rods delimiting the by-pass region on two sides. The 24 outer rods formed a guard ring with the cold shroud. This configuration prevented thermal conduction through the direct contact between the cladding balloons and the shroud, as was the case for blockages located on the edge of the assembly in FEBA and SEFLEX tests.

Ballooning of the rod cladding was simulated by superimposing a pre-shaped Inconel sleeve. The maximum blocked region extended over 200 mm, with entry and exit tapers, 200 mm and 50 mm long respectively, connecting the circular rod section with the sleeve square section. The cladding balloons therefore occupied almost a complete grid interval. The sleeve thickness in the maximum deformed region was 0.3 mm, which is comparable to that of a real cladding balloon.

2.2.2 Tests with a 90% blockage ratio

Preliminary separate effects test series were performed in order to investigate the influence of 1) system pressure, 2) inlet temperature and 3) reflood rate. These series were conducted with constant power during the transient. Subsequent tests were run with a variable power rate, based on a best-estimate residual power law applied to the hot rod power in Sizewell B and transposed to a THETIS sub-channel flow passage (+65%) in order to obtain the same coolant enthalpy increase between inlet and rod mid-plane level. This scaling gives similar heat fluxes in the maximum heat flux region (1285 kW/m² for THETIS, in comparison to 1389 kW/m² for Sizewell B with nominal power).

Using this decay power curve, a series of 4 tests were performed with reflood rates of 6, 4, 3 and 2 cm/s at an input temperature of 90°C. However, for the two lowest reflood rates, initial bundle temperatures were reduced by approximately 100°C at mid-plane in order to avoid excessive heating in the blockage. Temperature variations in the upper part of the

blockage and the by-pass at the same level for reflood rates of 3 and 2 cm/s are provided in figures 4 and 5. Despite a reduction of 100°C in initial temperatures, an increase in the balloon temperature was observed at a much earlier stage for these reflood rates than for reflood rates of 3.7 cm/s or more.

[Insert Figures 4 and 5]

- For a reflood rate of 2.9 cm/s (figure 4), the maximum balloon temperature reaches 755°C, 60°C higher than the peak temperature in the by-pass.
- For a reflood rate of 2 cm/s (figure 5), the balloon temperature rises much faster, reaching the limit of 800°C at about 190 s. The temperature reaches 830°C at 220 s and power was run down from 157 kW to 8 kW over a period of 60 s. Despite this reduction in power, the balloon temperature continues to rise for another 50 s, reaching a maximum of 850°C before rapid cooldown that precedes rewetting at 335 s. It is therefore difficult to predict the maximum temperature that may have been reached if the programmed power decay had been maintained.

2.2.3 Tests with a 80% blockage ratio

The 80% blockage geometry only differs from the 90% blockage geometry by the sleeve section in the most deformed region and the corresponding tapers. A test matrix almost identical to that used for the 90% blockage tests was produced for the 80% blockage. It is interesting to compare selected results of the two test series performed under very similar conditions to obtain an indication of the impact of the blockage ratio upon the cooling of balloons in the blocked region. Comparisons only concern temperature variations in the blockage and by-pass with a variable residual power, as defined in the previous section using previously examined reflood rates.

Figures 6 and 7 compare temperature variations for a 2 cm/s reflood rate. It is important to remember that the 90% blockage T1R080 test underwent a power run down at 220 s in order to limit the maximum temperature that tended to rise in an unpredictable manner above the recommended value. Therefore, comparisons of temperature variations can only reasonably be made up until 220 s. As observed for higher reflood rate tests, blockage cooling improvement following the onset of liquid entrainment is more accentuated for the 90% blockage, thus leading after 30 s to a balloon temperature approximately 50°C lower than the corresponding temperature for the 80% blockage. This temperature difference then reduces

slightly to a difference of 30°C at 220 s, after which temperature variations can no longer be compared. The peak balloon temperature for the 80% blockage reaches 880°C at about 275 s, which suggests that the peak balloon temperature for the 90% blockage would have most probably surpassed this value if the power hadn't been run down. The rather surprising fact remains that, with a reflood rate of 2 cm/s, the 80% blockage is no better cooled than a 90% blockage for at least 220 s in the transient.

[Insert Figures 6 and 7]

2.2.4 Discussion: qualitative analysis of phenomena

Balloon temperature variations in the upper part of the blockage result from the combination of blockage effects upon flow hydraulics and heat transfers.

In terms of hydraulics, a blockage introduces a major singularity causing the coolant flow to divert into the by-pass. Straightforward methods for evaluating the flow rate in the blockage – validated by air flow tests – demonstrated that the mass flow rate in the blockage sub-channels is reduced approximately in proportion to the flow area for this type of long blockage. Consequently, the steam speed in the maximum blocked section is comparable to that in the unblocked section.

In terms of heat transfers, a significant change in heat fluxes per sub-channel unit of length could have been expected in the blockage in comparison to the by-pass. Once again, a straightforward evaluation of the different associated factors indicates that this is not the case, both for turbulent and laminar flow. This can be explained by the quasi-compensation of effects associated with the decrease in the hydraulic diameter: increase in the surface heat transfer coefficient and decrease in the effective transfer surface due to the geometry of the flow passage and extensive contact between fuel rods. The heat transfer coefficient per unit of length also remains practically the same for 80% and 90% blockages.

It could therefore be expected that the drastic reduction of steam flow in the blocked sub-channel (a factor of 10 in relation to the by-pass for a 90% blockage), associated with the equivalent in energy deposition, lead to considerable superheating of steam in the blockage in comparison to the by-pass. As heat transfer between the surface and the two-phase coolant occurs essentially by steam convection, the balloon surface temperature should also follow the steam temperature. However, the steam temperature – and therefore surface temperature – at

the blockage outlet is also highly dependent on the heat transfer between steam and the liquid droplets carried downstream from the quench front, and which can more or less penetrate the blockage. Figure 8 illustrates steam and droplet speeds entering the blockage that condition droplet penetration in the maximum blocked region.

[Insert Figure 8]

As flow in the maximum blocked region has been reduced in proportion to the flow area, the steam speed is therefore the same upstream from the blockage and in the maximum blockage region. In the 90% blockage, for example, the steam flow in the tapered region – where the flow passage decreases from 100% to 10% over 200 mm – is progressively diverted towards the by-pass. This diversion can be considered complete about half way along the entry taper, where the balloons come into contact, isolating the sub-channels. At this level (60% blockage), the flow passage has been reduced to 40% of its nominal value, which means that the steam speed must be 4 times slower here than in the maximum blockage level where the flow passage represents only 10% of its nominal value. Therefore, along the tapered entry region, the axial speed of steam falls by a factor of 4 over the first half before rising to its initial value over the second half.

When the quench front is rather far upstream, the entrained droplets are accelerated by the steam flow due to the progressive acceleration of steam caused by the heating and evaporation of the liquid. These droplets will reach the blockage entry with sufficient enough speed to break through the deceleration region and enter the maximum blocked region. Once in this smaller volume, the droplets can efficiently de-superheat the steam and limit heating of the reduced flow of steam. The greater the slowdown, the longer the transit time of the droplets in the blockage region and the greater the heat transfer from the steam to the liquid. This explains why the cooldown in the early stages of reflood is more efficient in the 90% blockage than in the 80% one, with the temporary development of a negative axial temperature gradient. The more erratic temperature variations in the 90% blockage also result from compensation between the surface-to-steam heat transfer and a varying equivalent or greater steam-to-liquid heat transfer. It is interesting to note that the “advantage” gained early in the reflood for the 90% blockage can possibly last long enough in the transient so that the peak blockage temperature remains lower than that observed for the 80% blockage test.

Later on during reflooding, as the quench front approaches the bottom of the blockage, the droplets experience only slight acceleration and fall back towards the blockage entry where they are swept aside into the by-pass, unable to break through the deceleration region. Without cooling from the liquid droplets, steam will superheat significantly in the maximum blockage section, driving the corresponding surface temperatures at the throat outlet.

2.2.5 Coolability of THETIS blockages

In summary, the series of forced reflood tests simulating a 90% blockage with a pressure of 2 bar and an inlet temperature of 90°C produced the following observations:

- With a 3 cm/s reflood rate, the blockage was found to be coolable, with the peak blockage temperature not exceeding the peak by-pass temperature by more than 60°C.
- With a 2 cm/s reflood rate, the maximum blockage temperature rose above the facility operating limit, which made it necessary to reduce power before the complete cooling of the blockage was achieved. It may therefore be believed that these test conditions do not permit suitable blockage cooling.

THETIS test results seem to imply that a long 90% blockage may no longer be coolable at a constant reflood rate below 2 to 3 cm/s.

When comparing results of tests performed with 90% and 80% blockages under similar conditions, it became apparent that an 80% blockage is more efficiently cooled at high reflood rates. However, differences tended to be minor, sometimes proving to be even better for the 90% blockage with intermediate reflood rates that are most relevant to reactor safety analysis. These results therefore reveal that the blockage ratio of 90% – considered as an upper bound value of the flow blockage ratio possibly obtained under a LOCA with a fresh fuel assembly – does not necessarily represent the most penalising case in terms of coolability for extended axial deformations such as those simulated in the THETIS experiments.

2.3 FLECHT SEASET programme

The FLECHT SEASET programme (Full Length Emergency Cooling Heat Transfer – Separate Effects and System Effects Tests) (Hochreiter L.E., 1985) was an extensive programme that was launched in 1977 in cooperation between USNRC, EPRI and Westinghouse. The programme's main objective was to improve understanding of the complex thermohydraulic phenomena occurring during a hypothetical LOCA scenario. In the short term, programme results were to be used to identify excessive conservatism in

licensing requirements, such that realistic yet conservative requirements could be developed. In particular, a short-term goal was to obtain reflood heat transfer data and the subsequent analysis concerning partially blocked assemblies, which could be used to assess the relevance of the Appendix K rule relative to heat transfer under flow blockage conditions. A long term objective of the FLECHT SEASET programme was to evaluate the behaviour of the entire primary cooling system during gravity reflood scenarios and understand the interactions with the core heat release to yield the observed variations in flooding rate and heat transfer.

The FLECHT SEASET test results were clearly expected to be used in the development of significantly improved analytical reflood models in computer codes such as RELAP-4 and 5, BART, TRAC and COBRA-TF. Conducted in parallel with tests, the analysis of results with COBRA-TF was expected to provide a sufficient physical basis to modify the Appendix K steam cooling rule and establish more realistic requirements, thereby providing the industry with more flexible operating margins.

The FLECHT SEASET programme part dealing with blocked assembly cooling involved three main tasks:

- Performing tests on a 21-rod array to determine the effects of different blockage configurations and geometries upon reflood heat transfer;
- Performing tests on a 163-rod array to evaluate the effect of a large flow by-pass under the most severe heat transfer conditions observed in the 21-rod bundle test series;
- Analysing results and developing associated models with the COBRA-TF code.

Average blockage ratios tested in the FLECHT SEASET programme remain rather moderate, no higher than 62% in the most detrimental coplanar configuration. Furthermore, the simulated balloons in this configuration were particularly short, 60 mm in total length for a cosine profile. Therefore, results of these tests cannot be compared to test results with high blockage ratios from previously discussed programmes. It is nevertheless interesting to examine these test results owing to their particularities, such as several test series that were conducted with non-concentric and non-coplanar balloon configurations. Only the results of the 21 rod array tests will be discussed here.

2.3.1 Experimental characteristics

A review of existing information regarding ballooning and blockage results made it possible to choose 6 blockage configurations for the test series performed on a 21 rod array. Table 1 lists these different configurations with appropriate comments.

[Insert Table 1]

In non-coplanar configurations (D, E, F), the axial distribution of blockage sleeves was based on the principle that the axial distribution of deformations coincides with the axial temperature distribution. It was further assumed that all fuel rods shared a similar temperature distribution, but that the maximum temperature values were statistically distributed after having taken into consideration local variations resulting from variations in manufacturing parameters and in-reactor effects. Finally, a standard deviation of 7°C, combined with the axial mean temperature distribution of Westinghouse, using a standard statistical model for maximum temperature distribution, permitted the definition of an axial distribution of the blockage sleeves in a 21 rod array.

Based on ORNL and REBEKA burst tests, a strain of 36% was chosen as the most representative value and applied to all non-concentric balloons in configuration E. A slightly greater deformation (44%) was applied in configuration F.

Short concentric balloons in configurations B, C and D were 58 mm long and “long” non-concentric balloons in configurations E and F were 190 mm long, but with deformation essentially located over a length of 95 mm. These balloons were simulated by hollow sleeves fitted to the rods; the sleeves were obtained by hydraulic deformation of stainless steel tubes in a mould.

Regarding non-concentric sleeves, the selection of bulge directions was based on the following principles:

- Orientation of maximum deformation towards the centre of a sub-channel rather than towards an adjacent rod (for practical reasons : fitting the sleeves onto the rods);
- Burst on the hot side, with bowing and ballooning towards the cold side;
- Comparison with the 163 rod configuration containing guide tubes which are a source of azimuthal heterogeneity orienting the balloons towards the cold spots.

Figure 9 illustrates the axial distributions of bundle-wide blockage ratio for configurations C, D, E and F, all with a sleeve on all 21 fuel rods. As expected, configuration C (coplanar concentric) produces the highest blockage ratio (62%), whereas the non-coplanar configurations barely reach a maximum bundle blockage ratio of 30%, even if the local blockage in a specific sub-channel can reach much higher values (90%).

[Insert Figure 9]

The test assembly was composed of 21 full-length heater rods, with a diameter of 9.5 mm and a heated length of 3.05 m, held in 8 spacer grids and including 4 triangular solid fillers. The assembly was housed in a stainless steel cylindrical shroud, with an inside diameter of 6.82 mm and a thickness of 4 mm.

2.3.2 Test matrix

All configurations were subjected to hydraulic characterisation tests, steam cooling tests, and forced and gravity reflood tests (except for configuration F without gravity reflood tests). Forced reflood tests, which represented the main part of the different series, were performed to evaluate the effects of a blockage upon two-phase flow heat transfers. Gravity reflood tests were performed to ensure that no unexpected effects under gravity reflood could cause a more detrimental situation in terms of heat transfer in comparison to a forced reflood. In total, 87 forced reflood tests and 10 gravity reflood tests were conducted. Forced reflood tests were used to study the separate effects of variations upon the different test parameters:

- Reflood rate: from 1.27 cm/s to 15.2 cm/s ;
- Pressure: from 1.4 bar to 2.8 bar;
- Inlet fluid temperature sub-cooling: 22°C and 78°C
- Initial peak linear power: from 0.89 kW/m to 2.57 kW/m.

The same set of test conditions were used for each configuration.

Results for coplanar blockage

Figures 10 and 11 illustrate temperature variations on the central rod and a peripheral rod respectively, in the three configurations: no blockage, blockage with by-pass and blockage without by-pass. Temperatures were measured at 1.93 m or 1.91 m respectively, approximately 3 to 5 cm downstream from the upper end of the blockage, centred at 1.85 m.

[Insert Figures 10 and 11]

Following a short period of about 15 s after flood during which temperature variations appear indistinguishable – corresponding to the start of boiling at the assembly bottom – the temperature rise slows down in blockage configurations, particularly in the configuration without by-pass. This decrease in the temperature rise results from cooling generated by liquid droplets carried in the steam flow, which is even more pronounced when this flow is deprived of a by-pass. For the central rod, the difference in maximum temperatures approaches 100°C between the blockage-free configuration and the blockage configuration without by-pass, and about half that value between the blockage-free configuration and the blockage configuration with by-pass. However, for the latter configuration, the temperature after turnaround finally exceeds the temperature in the blockage-free configuration.

For the peripheral rod, temperatures variations are similar to that for the central rod until vicinity of the quenching with a maximum difference in temperatures about 130°C. In configuration B, the peripheral rod is located in the by-pass region and is thus subjected to a higher flow rate than the corresponding flow rate in the blockage-free test. Therefore, this peripheral rod has a lower temperature than the corresponding rod in configuration A. In configuration C without by-pass, the peripheral rod does not benefit from this additional flow and its temperature would be expected to be higher than the corresponding rod in configuration B; the observation of an opposing result indicates that the cooling effect of the liquid droplets upon the balloon dominates the cooling effect of the by-pass flow.

Results for non-coplanar blockage

In configuration D with short concentric sleeves, axial overlapping between sleeves of adjacent rods does not generally occur and the blockage ratio is rather low (< 13%). This blockage configuration is thus expected to have little effect upon heat transfers. It can also be expected that a short balloon in a non-coplanar blockage has a much less significant isolated effect upon the fragmentation of droplets in the adjacent sub-channel than for a coplanar blockage where this effect is reinforced by the neighbouring rod balloons. This is illustrated in figure 12, which provides steam temperature variations at the blockage outlet level and shows that the temperature is similar to that in the unblocked configuration, therefore indicating a poor steam de-superheating by the liquid droplets downstream from the blockage.

In configurations E and F with long non-concentric sleeves, considerable axial overlapping was observed between neighbouring balloons. Figure 13 compares steam temperature variations at the blockage outlet for configurations A, E and F and reveals considerable de-superheating of the steam in blockage F in which the balloons have the greatest circumferential strain (44%). This de-superheating is a result of greater droplet break-up and evaporation when passing through the blockage.

[Insert Figures 12 and 13]

Using a single-phase flow redistribution and heat transfer data from the least favourable 21-rod bundle blockage configuration, preliminary calculations with the COBRA-IV-I code for the 163 rod array , revealed that the detrimental effect of the flow by-pass could possibly overrule the beneficial effect of the heat transfer improvement in the blockage. In the continuation of the 21-rod array tests, a series of forced and gravity reflood tests were thus performed on a 163-rod array, whose dimensions were typical of a PWR fuel assembly. The purpose of these tests was to evaluate the possible additional effects of an ample flow by-pass, based on the most detrimental 21-rod bundle configuration in terms of heat transfer.

The main conclusion derived from the 163-rod array test results was that the beneficial effect of the blockage upon the increase in heat transfer remains sufficiently dominant, at least at the beginning of the transient. This compensates for the detrimental effect of the flow by-pass and produces lower maximum temperatures in comparison to those obtained in a blockage-free configuration.

2.4 FLECHT SEASET flow blockage programme conclusions

Blockage tests carried out in the FLECHT SEASET programme mainly focused on assessing the conservative aspect of the Appendix K rule with regard to the evaluation of heat transfer during reflood of a partially blocked assembly. In this respect, FLECHT SEASET 21-rod array test results – backed up by FEBA 25-rod array test results – highlighted the importance of considering the two-phase nature of the flow and the considerable influence of the liquid droplets field via:

- The entrainment of droplets in the steam flux even at low reflood rates (2.5 cm/s), which are swept into the blockage region when they have sufficient inertia;

- The shattering of these droplets on balloon surfaces, creating finer droplets, more easily evaporated, hence increasing steam de-superheating and surface heat transfer both in and downstream from the blockage.

The FLECHT SEASET 163-rod array tests (with a significant flow by-pass) confirmed the 21-rod array test results, illustrating that the beneficial effects resulting from the increase in blockage heat transfer override the penalty of flow diversion in the by-pass, which produced maximum temperatures below those obtained in blockage-free tests under comparable conditions.

3 ANALYTICAL DEVELOPMENTS

3.1 Analysis of results with the COBRA-TF code

As previously pointed out, an important objective of the FLECHT SEASET programme was the development of analytical models to evaluate the effect of a blockage in a reactor calculation. A mechanistic approach combining a physically-based model for blockage heat transfer with an advanced two-phase flow computer code was chosen for this purpose. The COBRA-TF code was selected and the FEBA tests results were used in combination with the 21-rod FLECHT SEASET tests to develop and validate COBRA-TF blockage models. Models were specifically developed to deal with heat transfer enhancement phenomena in the blockage, such as:

- Single phase convective enhancement in the film boiling region;
- Heat transfer via the impact of droplets on the blockage surfaces;
- Droplet break-up in the blockage.

A key feature of blockage heat transfer modelling was the integration of an additional field for fine liquid droplets shattered by impact into the COBRA-TF computer code, in order to handle the increased evaporation of these droplets.

As a short illustration of COBRA-TF performance versus FLECHT-SEASET data, figure 14 compares experimental and calculated values of cladding axial temperature distribution at 60 seconds for a 21-rod coplanar blockage test with short concentric balloons (configuration C). The figure shows fair agreement between experimental and calculated values.

[Insert Figure 14]

COBRA-TF calculations were then compared with 163-rod blocked bundle test results, without any change in the blockage models used in 21-rod calculations. Calculations and experimental results correspond as well as they did for the 21-rod array configuration.

3.2 CEGB model

An analytical model was developed in the UK by the Central Electric Generating Board (CEGB) (Adron and Fairbairn, 1982) to calculate cladding temperatures in an assembly blockage under LOCA reflood. This model is based on an idealised geometry in which a blockage is formed by axisymmetrical coplanar clad ballooning on a group of rods in the assembly. The coolant is a steam flux carrying droplets, but only the behaviour of steam is described. The model calculates:

- The steam velocity in the blockage sub-channels, based on flow redistribution upstream from the blockage;
- The cladding temperature in the ballooned region, or the difference ΔT_w between balloon and by-pass temperatures at the same elevation.

3.2.1 Comparison of model predictions with experimental results

A brief comparison of model predictions with FEBA 62% and 90% blockage results was carried out. Model predictions were consistent with the experiment for the 62% blockage with a 50°C to 100°C cooldown of the blockage in comparison to the by-pass. However, for the 90% blockage, the model predicted a 50 to 100°C temperature increase ΔT_w , whereas a cooldown of about 150°C was observed in the test. According to the authors of the analysis, this inconsistency could be partially due to the fact that the FEBA blockage was located in a corner of the assembly with the possibility – particularly the 90% blockage – of considerable thermal leakage by conduction with the cooler shroud.

3.2.2 Parametric calculations under PWR reflood conditions

Using the previously described model, a set of calculations was carried out to evaluate maximum temperatures in the blockage under PWR reflood conditions, with the length of the maximum blocked section (l) and its blockage ratio (τ) serving as the main parameters. Conditions recorded during FLECHT SEASET Run 31805 were chosen to define the thermohydraulic conditions and temperature for the non-deformed rods:

- Reflood rate = 2 cm/s

- Pressure = 2.8 bar
- Power = typical reactor decay power of a highly rated rod
- T_w = 1171°C (= maximum temperature in the bundle centre)
- Mass flow G_0 = 14.2 kg/m²/s

Two series of calculations were performed:

- a) Conservative calculations without steam de-superheating ($\chi = 1$),
- b) Best-estimate calculations with steam de-superheating: ($\chi = 0.4$) ;

(χ representing the fraction of the wall heat flux assigned to the increase in steam enthalpy).

Figure 15 illustrates the maximum temperature difference ΔT_w between the blockage throat and the by-pass as a function of the blockage length l and with the blockage ratio τ serving as a parameter. The solid lines refer to the case $\chi = 1$, whereas the dashed lines refer to the case $\chi = 0.4$. This figure shows that negative ΔT can be obtained for low blockage ratios ($\tau < 40\%$) and short blockages ($l < 100$ mm). The figure also reveals a very rapid increase in ΔT_w with blockage length for high blockage ratios ($\tau > 80\%$) due to steam superheating in the blocked passages. Consideration of steam de-superheating by liquid droplets lowers the temperature increase significantly, but still allows the possibility of high ΔT_w for long severe blockages, such as those of THETIS 90% blockage tests.

[Insert Figure 15]

In conclusion, trends revealed by this parametric study appear to be consistent with previously discussed experimental programme results, therefore confirming the absence of temperature penalties for short blockages or moderate blockage ratios (<60%). Furthermore, significant increases in blockage surface temperatures that may threaten blockage coolability require high blockage ratios (>80%) and long blockages (longer than 150 mm).

4 CONCLUSIONS

Vast experimental programmes have been devoted to answering the question of coolability under postulated LOCA conditions of an assembly containing a partial blockage. All of these programmes have focused on large break LOCA scenarios and more particularly on blockage

cooling under reflood conditions. Examination of these main programmes has helped establish a more global understanding of the physical processes involved in such a situation.

4.1 Main results from experimental programmes

Temperature variations in and downstream from a blockage region in a fuel rod assembly resulting from cladding deformation during a LOCA transient are generally conditioned by heat transfers taking place at the beginning of the reflood phase with two-phase mist flow conditions. A blockage induces antagonistic effects whose relative significance depends on the geometrical conditions of the blockage and its by-pass, as well as the thermohydraulic conditions of the reflood. These effects result from the following physical phenomena:

- Reduction of the flow passage in the blockage leads to flow diversion towards the by-pass, therefore reducing the mass flow in blockage sub-channels. For sufficiently long blockages (≥ 200 mm), the reduction in the steam flow is approximately proportional to the reduction in the cross section area. This reduction in coolant flow therefore tends to restrict blockage coolability.
- However, in a two-phase flow, the inertia of droplets favours their penetration of the blockage, particularly if the quench front is sufficiently far off to have permitted their acceleration in the steam flow. Inside the blockage, the liquid droplets are dispersed due to their impact on the blockage surfaces, fragmented and re-entrained in the form of finer droplets, which significantly increases heat transfer with steam. This de-superheating of steam, associated with the increase in turbulence, improves the coolability of the blockage surfaces.
- At the blockage outlet, the deceleration of the steam flow in the widening section can cause bigger droplets to fall under gravity onto the hot blockage surfaces, thereby leading to dispersion and evaporation in steam jets, which once again leads to an accentuated cooling in the region.

In the programmes discussed in this review, the experimental characteristics – particularly blockage dimensions (blockage ratio, blockage length, cladding balloon thickness, configuration, etc.) and initial test conditions reveal the relative importance of each beneficial or detrimental phenomenon indicated above and consequently their influence upon test results. This review has attempted to compile the most specific information from these different programmes, dealing namely with:

- Blockage representativity,

- Effect of blockage ratios,
- Effect of blockage lengths,
- Effect of blockage configurations: coplanar or non-coplanar,
- Effect of reflood characteristics: forced/ gravity.

Pooling the various different test results helps improve our understanding of the physical phenomena governing the behaviour of a partially blocked assembly during a LOCA reflood scenario. This also helps clarify the coolability limits of a blockage under the most penalising geometrical (blockage ratio and length) and thermohydraulic conditions. Thus, though it seems that blockages – even of significant ratios (90%) but of moderate lengths (<10 cm) – do not create any particular problems in terms of coolability, it should not be assumed, as one might be tempted to do considering FEBA and SEFLEX test results, that a 90% blockage is always coolable. It has also been demonstrated that the maximum blockage ratio of 90% does not necessarily represent the most penalising case in terms of coolability for axially extended deformations.

4.2 Analytical developments

Main efforts in terms of model development were made in association with FEBA and FLECHT SEASET tests. This model development was based on the COBRA-TF computer code, which is a best-estimate code developed to simulate the thermohydraulic behaviour of a water reactor assembly during a LOCA reflood scenario. Specific models were developed to calculate heat transfers in the blockage vicinity, such as the increase in steam convection, heat transfers via droplet impacts on blockage walls and droplet fragmentation within the blockage.

It was possible to confirm the dominant physical process related to droplet effects through the 1) development of blockage models based on 21-rod tests, 2) integration of such models into the COBRA-TF code and 3) analysis of 21- and 163-rod tests showing satisfactory agreement between model calculations and experimental values. The physical modelling of blockages using the COBRA-TF code seems therefore to provide a correct representation of actual blockage behaviour.

Simplified models were also developed in order to analyse THETIS tests and calculate cladding temperatures in a blockage under LOCA reflood conditions. A set of calculations

were performed to evaluate maximum blockage temperatures under PWR reflood conditions using this type of model, with the maximum blockage length and blockage ratio serving as main parameters. Trends highlighted by this parametric study correspond well with experimental programme test results, which 1) confirms the absence of penalising temperatures for short blockages and moderate blockage ratios (<60%) and 2) corroborates the fact that significant increases in blockage wall temperatures, which may threaten the coolability of the blockage, require high blockage ratios (above 80%) and long blockages (longer than 150 mm).

4.3 Pending questions

In conclusion, it is important to underline the fact that all results and trends discussed in this review were drawn from out-of-pile tests performed on assemblies containing electric fuel rod simulators. The fixed heated elements in these simulators cannot be used to simulate a possible accumulation of fuel in the balloons (fuel relocation) as was demonstrated in in-pile tests performed on irradiated fuel rods. Furthermore, the significant difference between comparable FEBA and SEFLEX programme test results seems to indicate that significant thermal coupling between the heat source and the ballooned cladding – as may exist in a clad balloon full of relocated fuel fragments – is susceptible of significantly hindering the coolability of a blockage with such balloons, in comparison to a case where fuel relocation does not occur. This question cannot be correctly investigated by extrapolating FEBA or SEFLEX test results. The effect of fuel relocation (leading to a local accumulation of power and quasi-closure of the gap in the blockage) upon the blockage coolability was not explored in any existing tests and therefore remains to be investigated in specific tests. Such tests should be conducted preferentially, as in those discussed above, on rod arrays bearing pre-shaped deformed regions, but with taking account of a local increase in power density and a reduction in gap width to simulate the relocation of fuel in the balloons.

REFERENCES

Adron, K.H., Fairbairn, S.A., 1982, *A Method of Predicting the Temperature Response of Ballooning Fuel Cladding for PWR LOCA Conditions*.

Int. Meeting on Thermal Nuclear Safety, Chicago, Aug. 28 – Sept. 2, 1982.

Cooper, C.A., Pearson, K.G., Jowitt, D., 1984, *The THETIS 80% Blocked Cluster Experiment. Part 3: Forced Reflood Experiments*. AEEW – R 1765, September 1984.

Grandjean, C., 2005, *A State-of-the-Art Review of Past Programs Devoted to Fuel Behavior Under LOCA Conditions. Part One: Clad Swelling and Rupture. Assembly Flow Blockage.* IRSN Technical Report SEMCA-2005-313, December 2005.

Hochreiter, L.E., 1985, *FLECHT SEASET Program Final Report.* NUREG/CR-4167; EPRI NP-4112; WCAP-10926, November 1985.

Ihle, P, Rust, K., 1984, *FEBA. Flooding Experiments with Blocked Arrays. Evaluation Report.* KfK 3657, March 1984.

Ihle, P, Rust, K., 1986, *SEFLEX. Fuel Rod Simulator Effects in Flooding Experiments. Part 1: Evaluation Report.* KfK 4024, March 1986.

Parsons, P.D., Hindle, E.D., Mann C.A., 1986, *The Deformation, Oxidation and Embrittlement of PWR Fuel Cladding in a Loss-of-Coolant Accident. A State-of-the-Art Report.*
NEA/OECD-CSNI Report 129, December 1986

Pearson, K.G., Cooper, C.A., Jowitt, D., Kinneir, J.H., 1983, *Reflooding Experiments on a 49-Rod Cluster Containing a Long 90% Blockage.* AEEW – R 1591, January 1983.

Pearson, K.G., Cooper, C.A., Jowitt, D., 1984, *The THETIS 80% Blocked Cluster Experiment. Part 4: Gravity Reflood Experiments.* AEEW – R 1766, September 1984.

USNRC/ONRR, 1988, *Compendium of ECCS Research for Realistic LOCA Analysis. Final Report.* NUREG-1230, December 1988.

LIST OF FIGURES

- Figure 1A: FEBA 5x5 bundle with 90% blockage
- Figure 1B: SEFLEX 5x5 bundle with 90% blockage
- Figure 2: FEBA 5x5 bundle geometries of test series I through VIII
- Figure 3: Temperatures measured at the midplane of a 90% blockage and in the blockage by-pass of FEBA and SEFLEX rod bundles.
- Figure 4: THETIS Run T1R082 (3 cm/s reflood rate)
- Figure 5: THETIS Run T1R080 (2 cm/s reflood rate)
- Figure 6: THETIS Run T2R043 (80% blockage, 2 cm/s reflood rate)
- Figure 7: THETIS Run T1R080 (90% blockage, 2 cm/s reflood rate)
- Figure 8: Schematic of axial variation of steam and drop speed along the blockage.
- Figure 9: Bundle-wide blockage and axial distributions for FLECHT-SEASET configurations C, D, E and F.
- Figure 10: FLECHT-SEASET 21 rods. Centre rod temperature for unblocked and coplanar blockage configurations.
- Figure 11: FLECHT-SEASET 21 rods. Peripheral rod temperature for unblocked and coplanar blockage configurations.
- Figure 12: FLECHT-SEASET 21 rods. Steam temperature for unblocked and non coplanar blockage (short sleeves) configurations.
- Figure 13: FLECHT-SEASET 21 rods. Steam temperature for unblocked and non coplanar blockage (long sleeves) configurations.
- Figure 14: Comparison of COBRA-TF calculated axial rod temperature versus elevation with FLECHT-SEASET 21-rod data, Run 42506C, t=60 s.
- Figure 15: CEGB model maximum predicted clad temperature increase in blockage throat as function of throat length and blockage ratio.

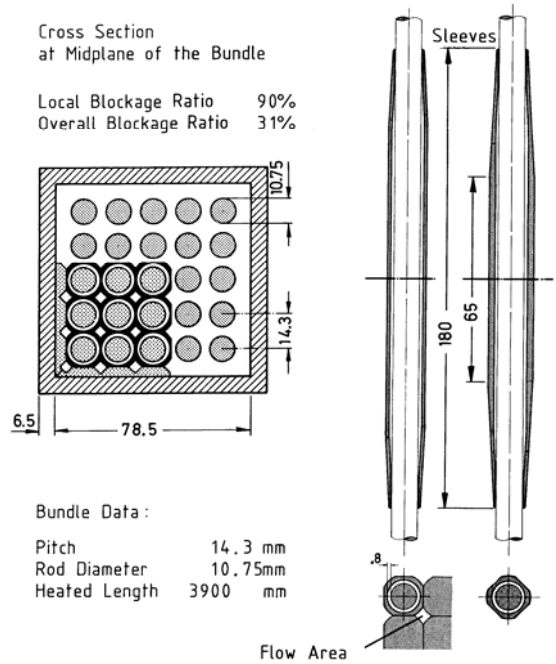

Figure 1A: FEBA 5x5 bundle with 90% blockage

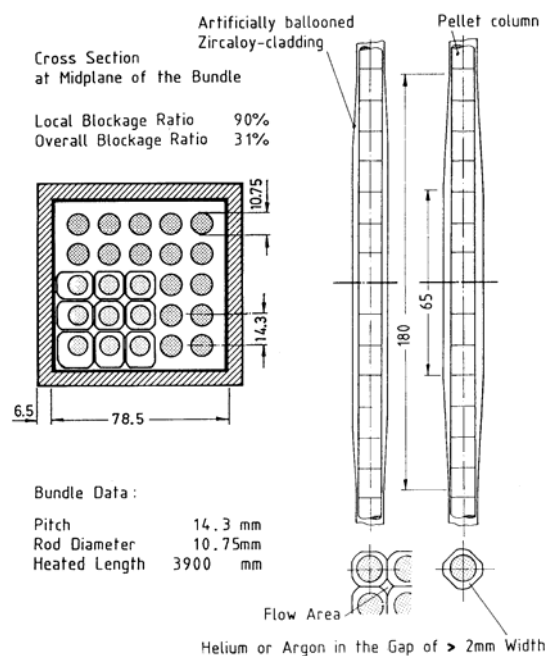

Figure 1B: SEFLEX 5x5 bundle with 90% blockage

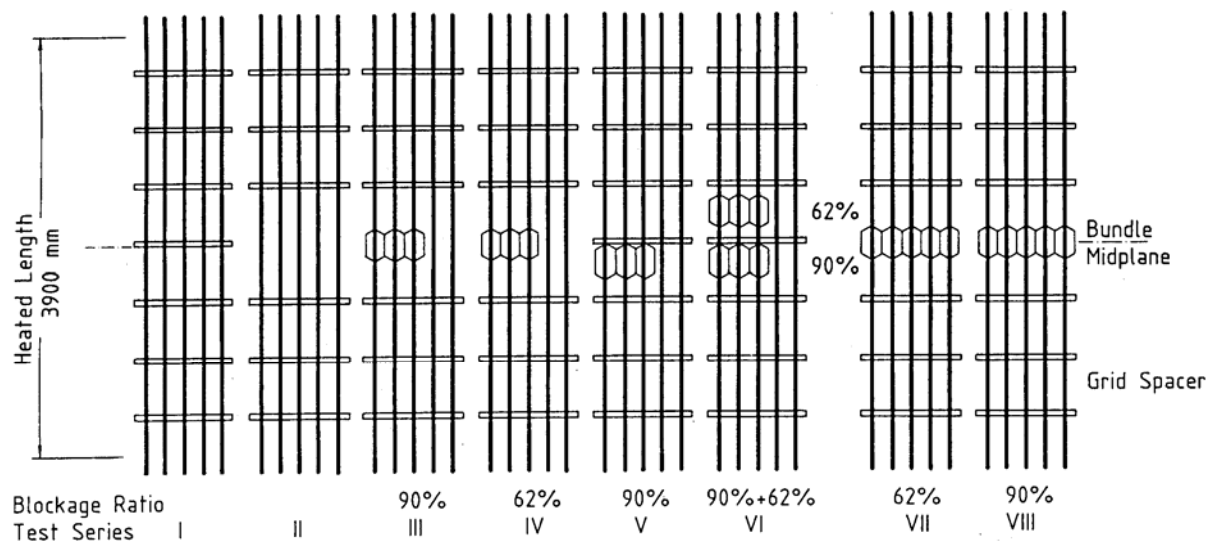
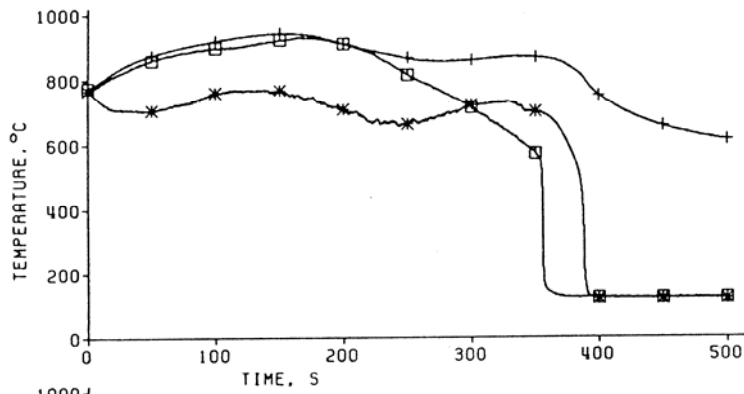
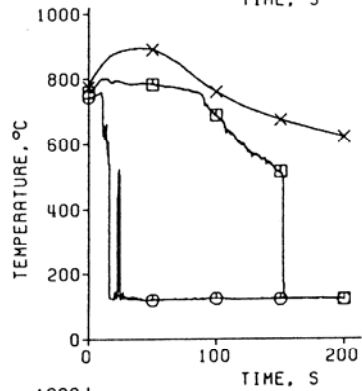

Figure 2: FEBA 5x5 bundle geometries of test series I through VIII



Plot A
FEBA test No. 241
FEBA rod bundle
Sleeve blockage

- Bypass, rod cladding
- * Blockage, sleeve
- + Blockage, rod cladding underneath sleeve



Plot B
SEFLEX test No. 32
REBEKA rod bundle
Ballooned claddings
Helium-filled gaps

- Bypass, rod cladding
- Blockage, rod cladding
- × Blockage, heater sheath

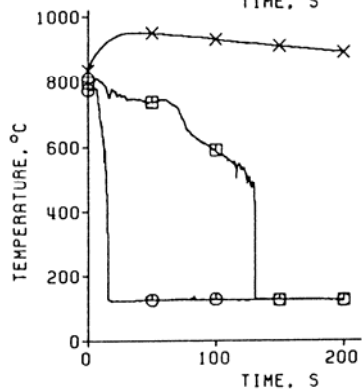

Plot C
SEFLEX test No. 33
REBEKA rod bundle
Ballooned claddings
Argon-filled gaps

- Bypass, rod cladding
- Blockage, rod cladding
- × Blockage, heater sheath

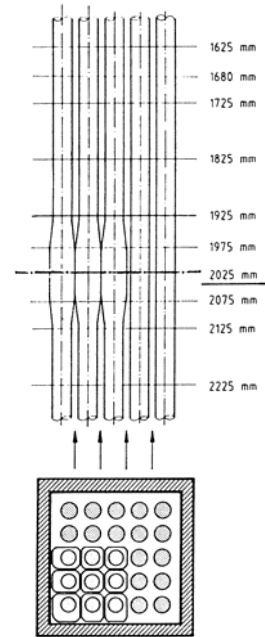

Figure 3: Temperatures measured at the midplane of a 90% blockage and in the blockage bypass of FEBA and SEFLEX rod bundles.

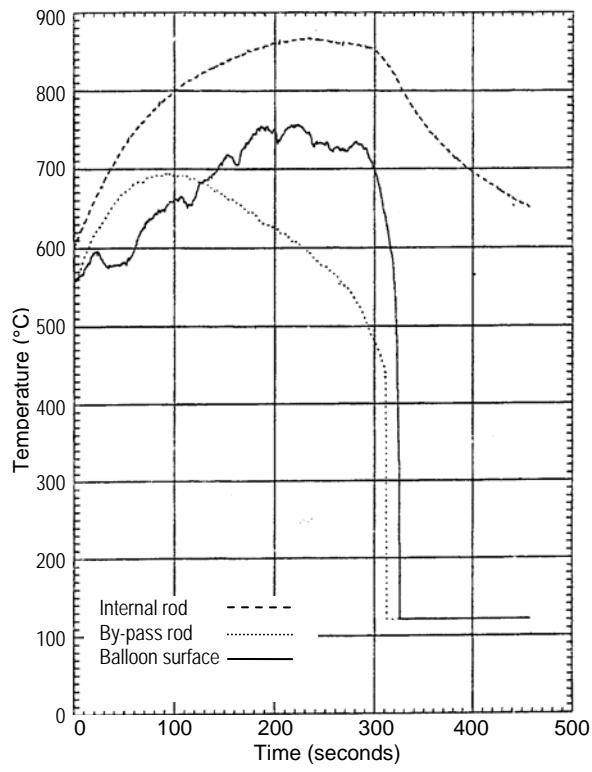

Figure 4: THETIS Run T1R082
3 cm/s reflood rate

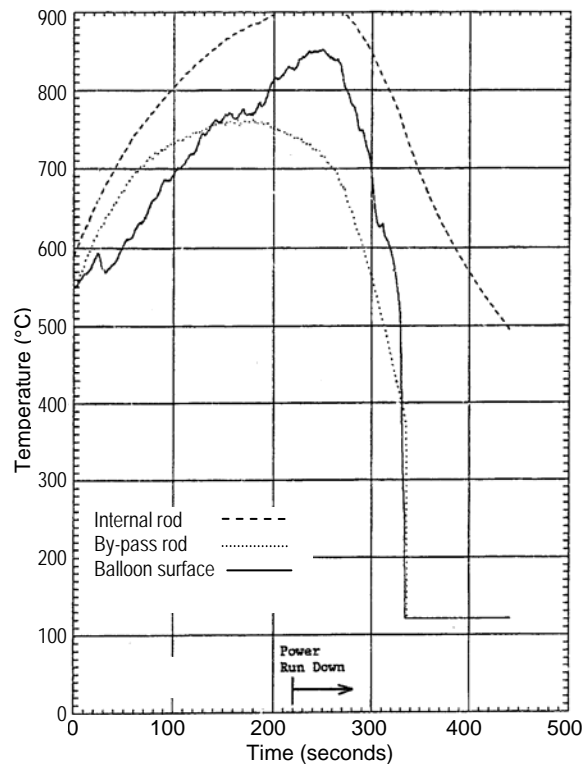

Figure 5: THETIS Run T1R080
2 cm/s reflood rate

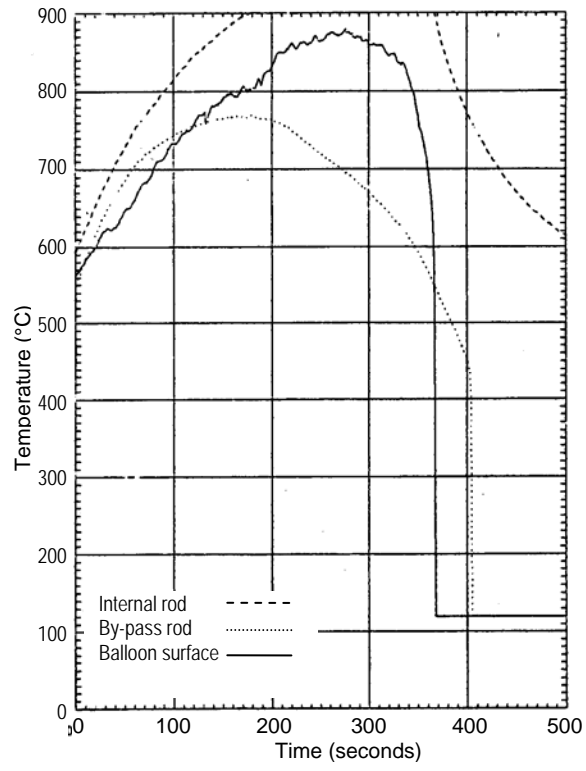

Figure 6: THETIS Run T2R043
80% blockage, 2 cm/s reflood rate

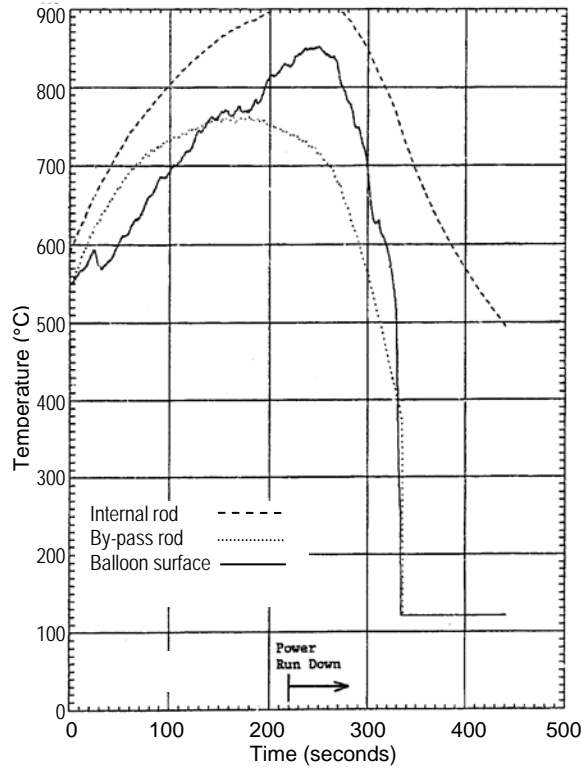

Figure 7: THETIS Run T1R080
90% blockage, 2 cm/s reflood rate

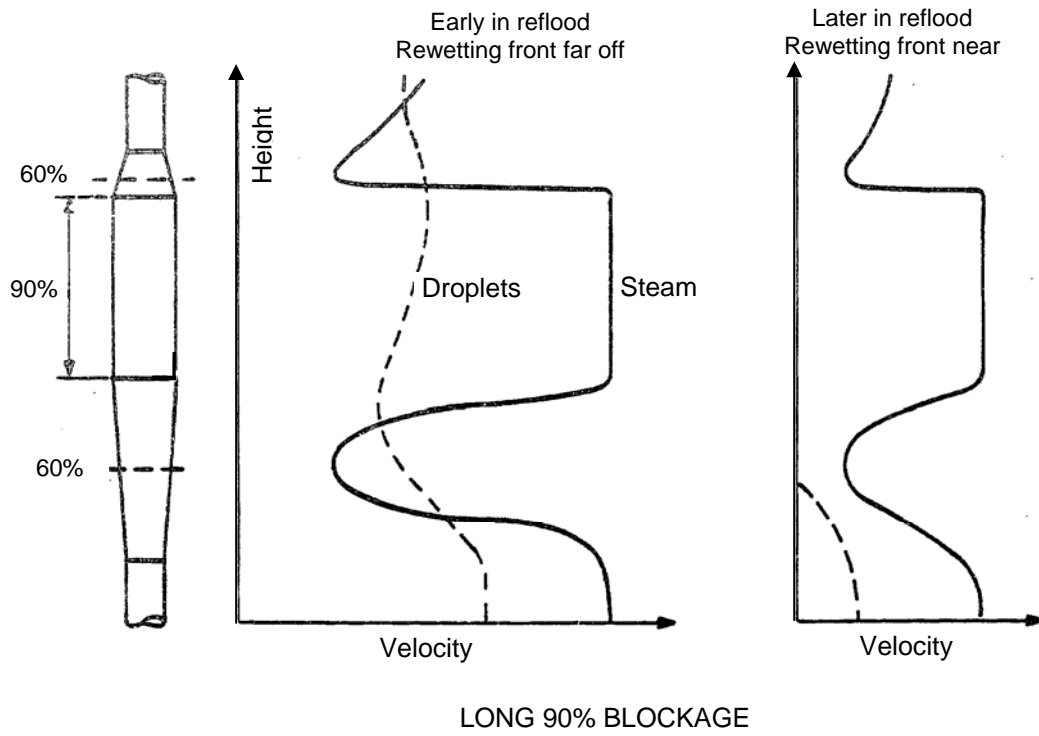

Figure 8: Schematic of axial variation of steam and drop speed along the blockage.

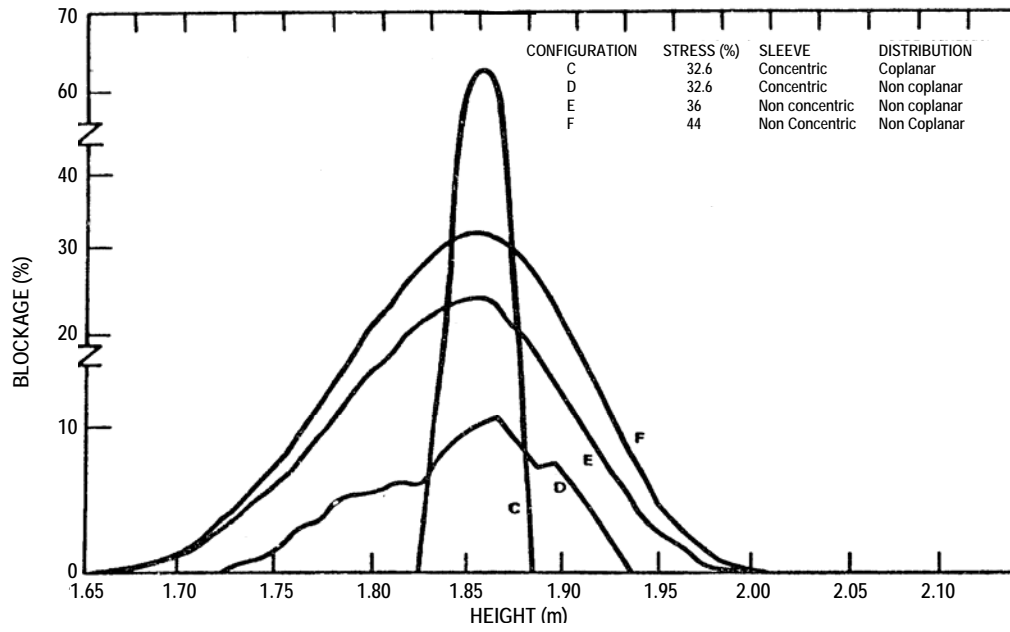

Figure 9: Bundle-wide blockage and axial distributions for FLECHT-SEASET configurations C, D, E and F.

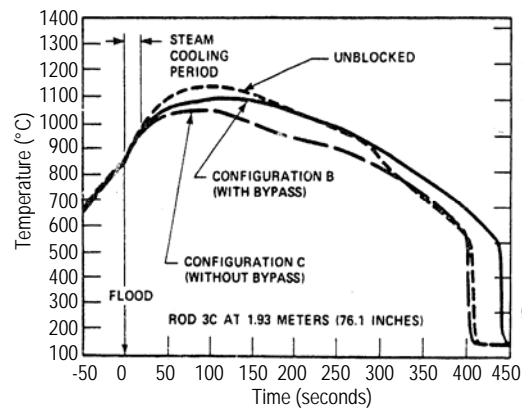

Figure 10: FLECHT-SEASET 21 rods.
Centre rod temperature for unblocked and
coplanar blockage configurations.

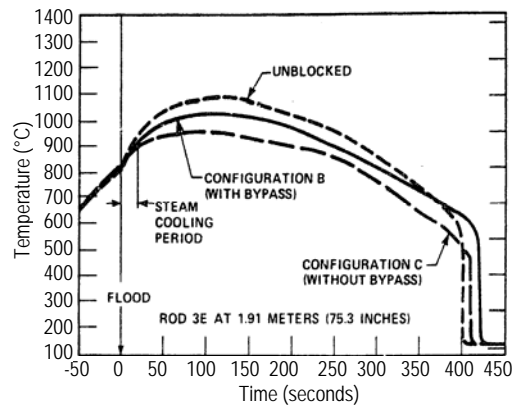

Figure 11: FLECHT-SEASET 21 rods. Peripheral rod temperature for unblocked and coplanar blockage configurations.

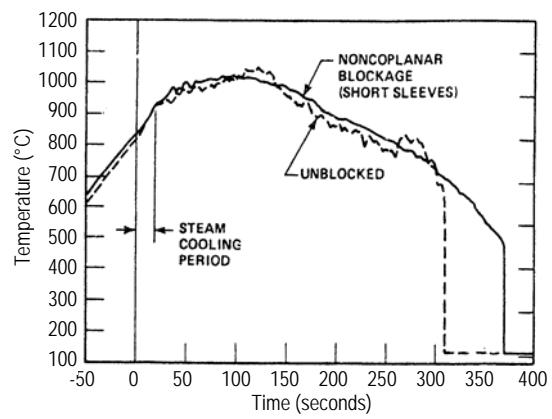

Figure 12: FLECHT-SEASET 21 rods. Steam temperature for unblocked and non coplanar blockage (short sleeves) configurations.

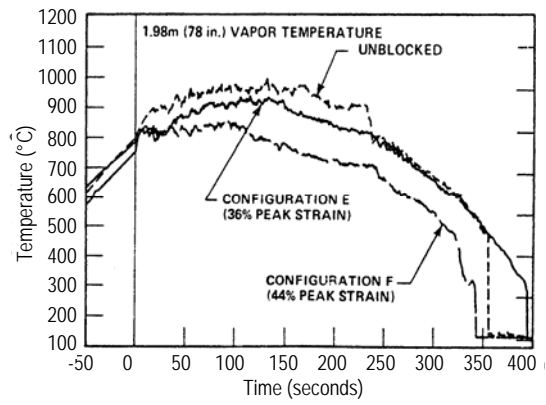

Figure 13: FLECHT-SEASET 21 rods. Steam temperature for unblocked and non coplanar blockage (long sleeves) configurations.

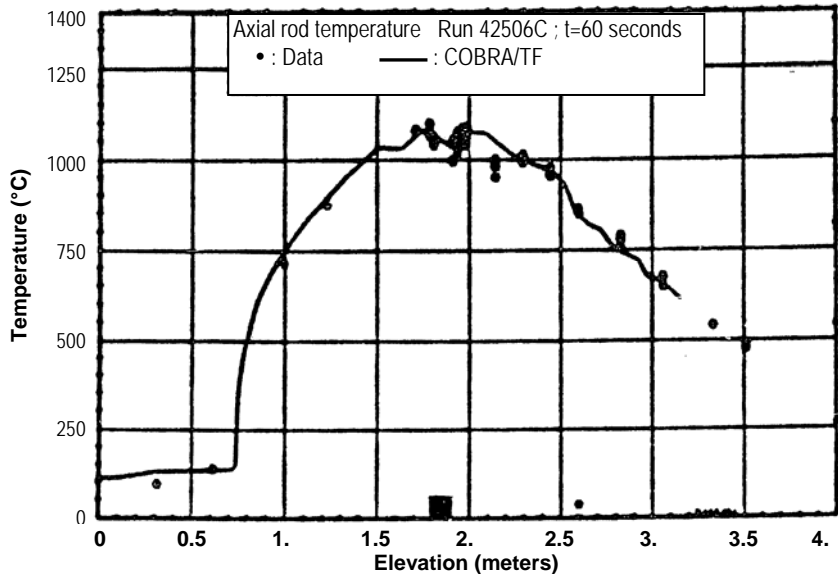
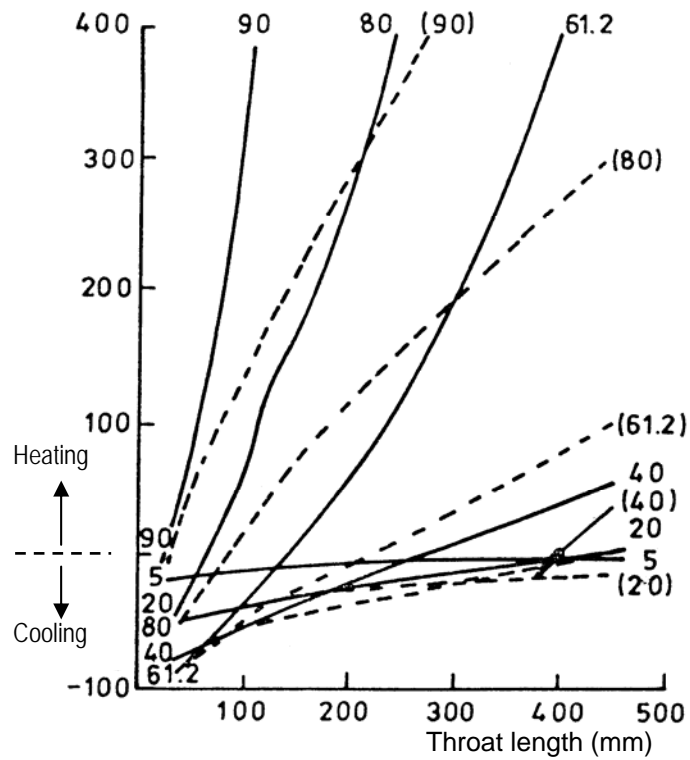

Figure 14: Comparison of COBRA-TF calculated axial rod temperature versus elevation with FLECHT-SEASET 21-rod data, Run 42506C, t=60 s.



.....: $\chi = 1$. (upper bound calculation) —: $\chi = 0.4$ (best-estimate calculation)
curve labels indicate % sub-channel blockage

Figure 15: CEGB model maximum predicted clad temperature increase in blockage throat as function of throat length and blockage ratio.

LIST OF TABLES

Table 1: Blockage shapes and configurations tested in FLECHT SEASET 21-Rod bundle.

Test Series	Configuration Description	Comments
A	No blockage on the rods	This configuration served as a reference.
B	Short concentric sleeve, coplanar blockage on 9 centre rods. Maximum strain = 32.6%	This series provided for both blockage effect and some by-pass effects.
C	Short concentric sleeve, coplanar blockage on all 21 rods. Maximum strain = 32.6%	This series was the easiest to analyze since it provided no flow by-pass effects with maximum flow blockage effect at one axial plane.
D	Short concentric sleeve, non-coplanar blockage on all 21 rods. Maximum strain = 32.6%	This test series examined a non-coplanar blockage distribution and was comparable to series C.
E	Long non-concentric sleeve, non-coplanar blockage on all 21 rods. Maximum strain = 36%	This test series permitted a one-to-one comparison with series D in which all rods were blocked. Comparison of series D and E with unblocked data indicated the worst shape.
F	Test series E with increased sleeve strain, non-coplanar blockage on all 21 rods. Maximum strain = 44%	This test series increased the blockage effect relative to series E.

Table1: Blockage shapes and configurations tested in FLECHT SEASET 21-Rod bundle.